

■ ABM-14 | PLATE AND PIPE BEVELLER

ABM-14 is a beveling machine designed to mill plates and pipes made of carbon steel, alloy steel, stainless steel or aluminum alloys.

In just one single run the machine can bevel up to 12 mm (1/2") width.

Maximum bevel width is 14 mm (9/16"). Depending on materials two or more runs are needed.

The machine can bevel plates from top and bottom. Two optional ergonomic trolleys are available to make operator's work more effective and comfortable.

Using an additional vertical roller guide ABM-14 can bevel concave edges if curvature radius is 1500 mm or larger.



■ Features & benefits

- bevels both small and large pieces to cover most of the common applications for its type
- auto feed on large plates with optional trolleys
- beveling of lower edge in inverted position
- standard shearing cutter for machining stainless/alloyed steel
- 2 optional shearing cutters dedicated to carbon steel and to aluminum
- reversible spindle against stuck milling tool
- versatile and transportable on its own trolleys
- low noise
- possibility to bevel concave edges

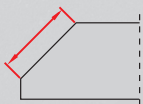

Bevel width
up to 14 mm
(9/16")



Bevel angles 30°,
(option): 22.5°, 25°,
35°, 37.5°, 45°



Min plate thickness
6 mm
Max plate thickness
40 mm (1-9/16")

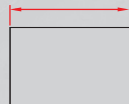

Min plate width
55 mm
(2-3/16")



Top
beveling



Bottom
beveling



Pipe OD beveling
Min. ID
100 mm (4")



Round plate
beveling
(option)

ABM-14 TECHNICAL SPECIFICATION

Voltage	3~ 400 V + PE, 50-60 Hz
Power	2200 W
Spindle speed	9 rpm (for 50 Hz); 11 rpm (for 60 Hz)
Bevel angle range (β - depending on angle device in use)	30° 22.5°, 25°, 35°, 37.5°, 45° (options)
Bevel width (b)	up to 14 mm (9/16")
Maximum bevel in one single run	12 mm (in 40 Kg/ 392 MPa carbon steel)
Minimum plate thickness	6 mm (1/4")
Maximum plate thickness	40 mm (1-9/16")
Minimum plate width	55 mm (2-3/16")
Bevel length per minute	2.6 m (8.5 ft) for 50 Hz; 3.1 m (10.2 ft) for 60 Hz
Minimum pipe ID	100 mm (4")
Weight	65 kg (144 lbs)
Product Code:	UKS-0639-10-40-00-0

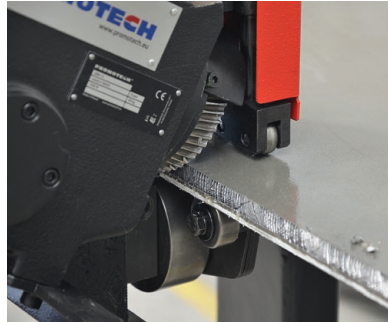
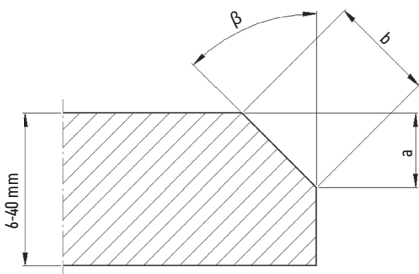

SINGLE RUN BEVELLING - CARBON STEEL

Rm	≤ 392 MPa (57,000 psi)		392-490 MPa (57,000-71,000 psi)		490-588 MPa (71,000-85,000 psi)	
	b [mm]	a [mm]	b [mm]	a [mm]	b [mm]	a [mm]
22.5°	12	11	10	9	8	7.5
30°	12	10	10	8.5	8	7
35°	12	9.5	10	8	8	6.5
37.5°	12	9	10	7.5	8	6
45°	12	8.5	10	7	8	5.5

SINGLE RUN BEVELLING - STAINLESS / ALLOY STEEL

Rm	≤ 490 MPa (71,000 psi)		490-588 MPa (71,000-85,000 psi)		588-686 MPa (85,000-100,000 psi)	
	b [mm]	a [mm]	b [mm]	a [mm]	b [mm]	a [mm]
22.5°	6	5.5	5	4.5	4.2	3.8
30°	6	5	5	4.3	4.2	3.6
35°	6	5	5	4	4.2	3.5
37.5°	6	4.5	5	4	4.2	3.3
45°	6	4	5	3.5	4.2	3

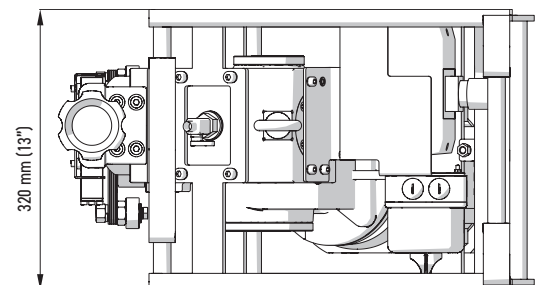
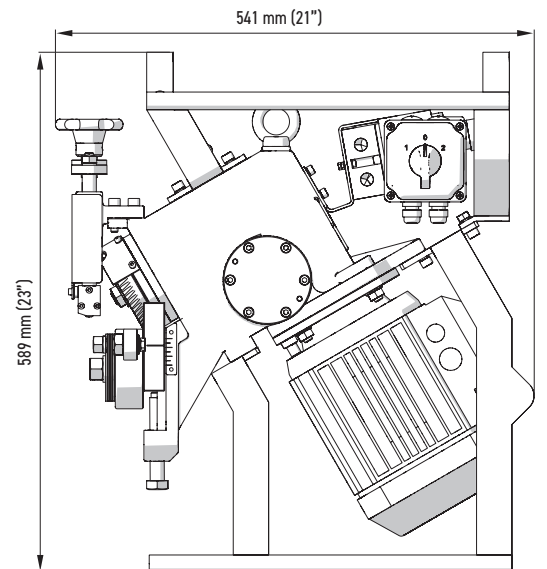

Standard set includes:

- ABM-14 beveller
- milling cutter for stainless steel
- angle variation device 30°
- cutter extraction tool
- tube beveling shaft
- tube beveling washer
- flat wrenches: 12-13 mm, 18-19 mm, 24-26 mm
- hex wrenches: 5 mm and 6 mm
- operator's Manual

Optional and spare accessories:



- FRZ-000586 Milling cutter for carbon steel
- FRZ-000588 Milling cutter for stainless steel
- FRZ-000587 Milling cutter for aluminum



- SCG-000002 Milling cutter extraction tool



- WOZ-0639-01-00-00-0 Adjustable trolley



- PRW-000100 Angle variation device 22.5°
- PRW-000101 Angle variation device 25°
- PRW-000105 Angle variation device 30°
- PRW-000102 Angle variation device 35°
- PRW-000103 Angle variation device 37.5°
- PRW-000104 Angle variation device 45°

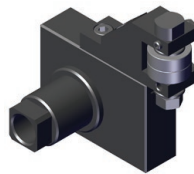

- SWK-0639-02-00-00-0 Vertical roller guide
Min. concave curve radius 1500 mm



- TRZ-000017 Tube beveling shaft
- PDK-000240 Tube beveling washer



- MNP-0675-10-00-01-0 Machine Rotation Trolley
- One man operation
- Easy positioning for top and bottom beveling
- Height adjustment from 600 mm to 1000 mm

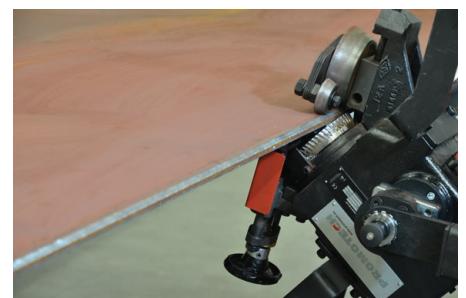
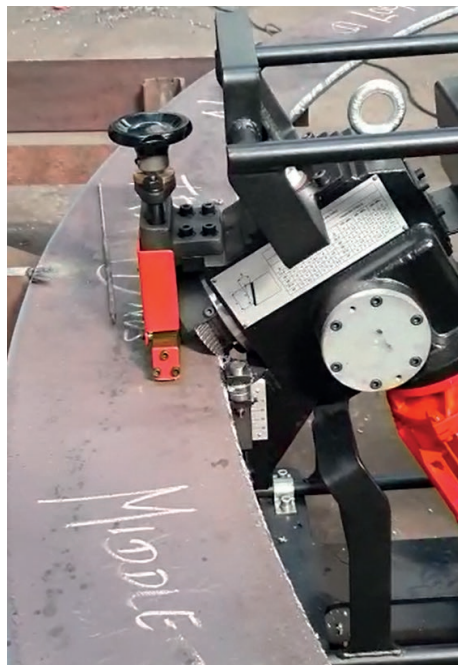

Multitude of applications:



Top plate beveling



Bottom plate beveling



Oval workpiece and pipe beveling



Beveling at 30°



Beveling at 45°



Maximum bevel width up to 14 mm



ABM-14 runs along a plate automatically

Top plate beveling with trolley

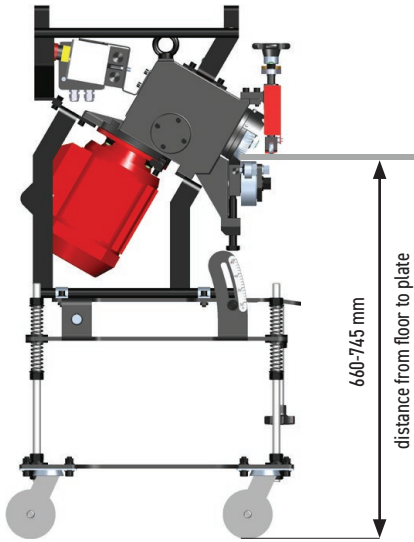

Configuration 1

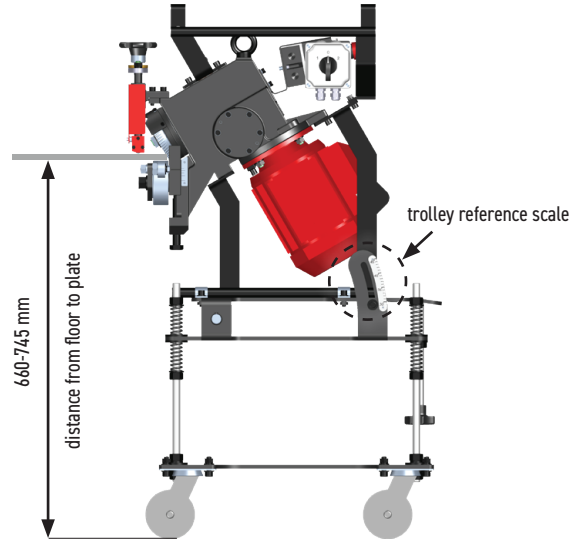

Configuration 2

Top beveling at 22.5 degrees

Configuration 1

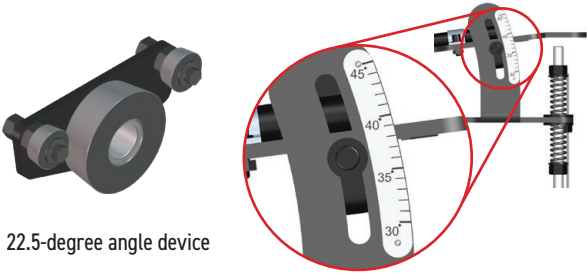

22.5-degree angle device

Trolley reference point set to 37.5-degrees

Top beveling at 35 degrees

Configuration 2

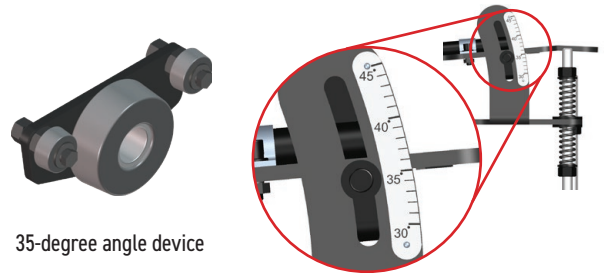

35-degree angle device

Trolley reference point set to 35-degrees

Top beveling at 25 degrees

Configuration 1

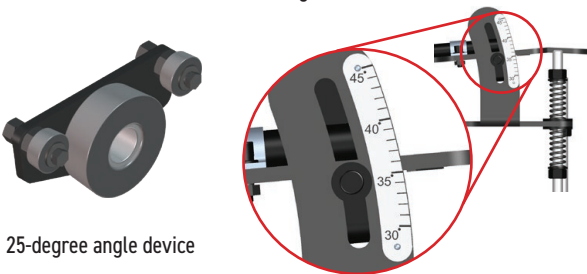

25-degree angle device

Trolley reference point set to 35-degrees

Top beveling at 37.5 degrees

Configuration 2

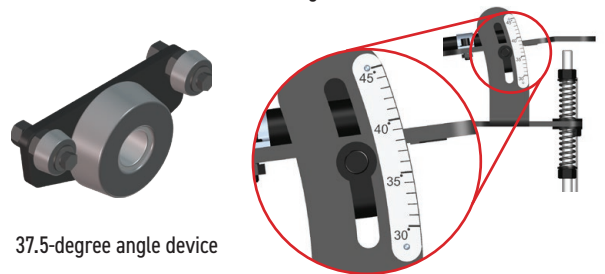

37.5-degree angle device

Trolley reference point set to 37.5-degrees

Top beveling at 30 degrees

Configuration 1 or 2

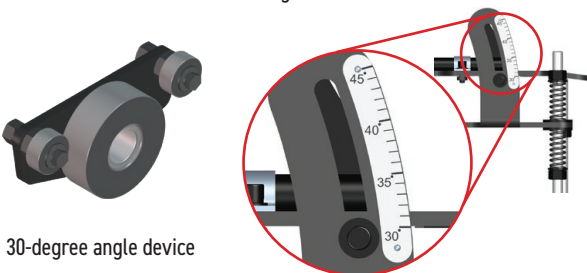

30-degree angle device

Trolley reference point set to 30-degrees

Top beveling at 45 degrees

Configuration 2

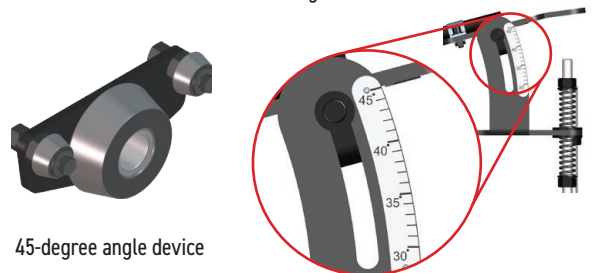

45-degree angle device

Trolley reference point set to 45-degrees

Bottom plate beveling with trolley

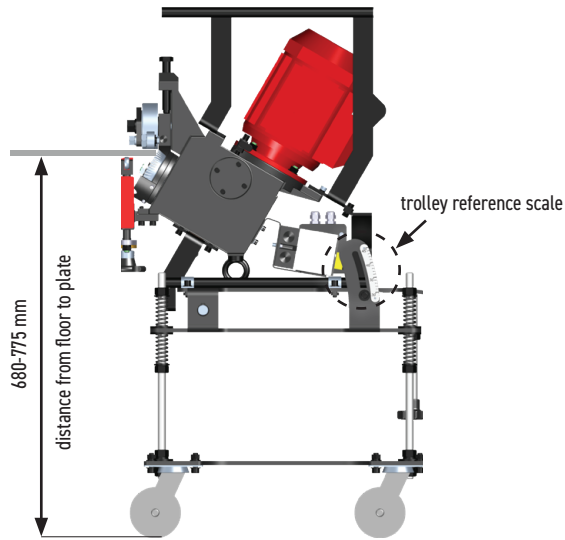

Configuration 3

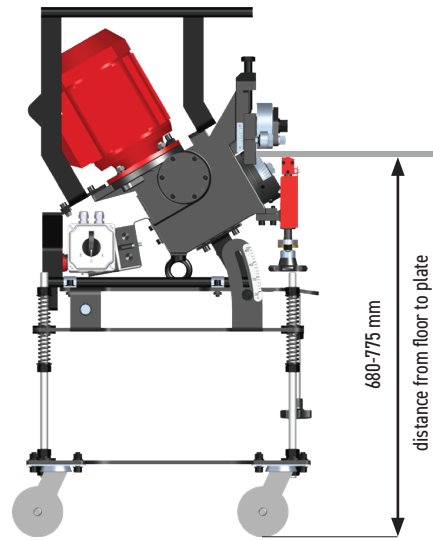

Configuration 4

Bottom beveling at 22.5 degrees

Configuration 3

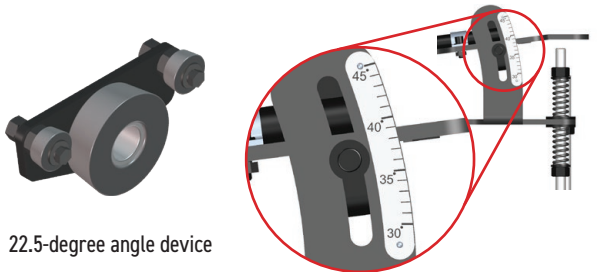

22.5-degree angle device

Trolley reference point set to 37.5-degrees

Bottom beveling at 35 degrees

Configuration 4

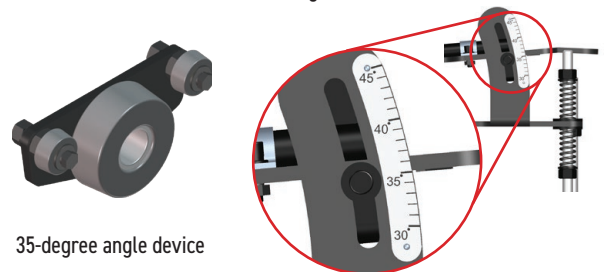

35-degree angle device

Trolley reference point set to 35-degrees

Bottom beveling at 25 degrees

Configuration 3

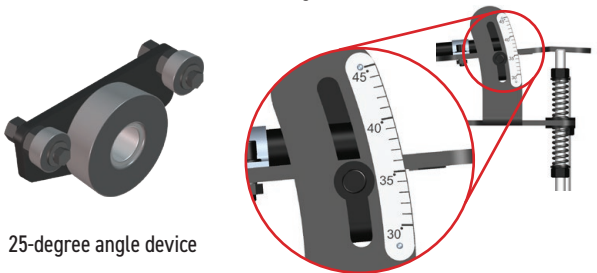

25-degree angle device

Trolley reference point set to 35-degrees

Bottom beveling at 37.5 degrees

Configuration 4

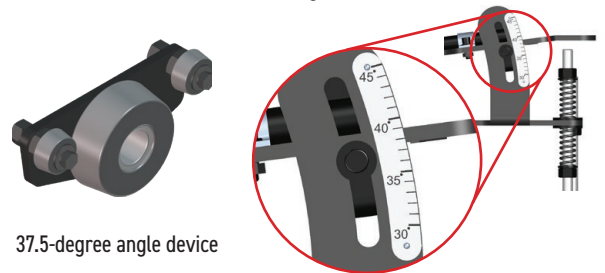

37.5-degree angle device

Trolley reference point set to 37.5-degrees

Bottom beveling at 30 degrees

Configuration 3 or 4

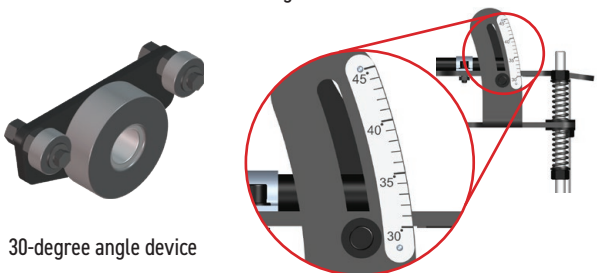

30-degree angle device

Trolley reference point set to 30-degrees

Bottom beveling at 45 degrees

Configuration 4

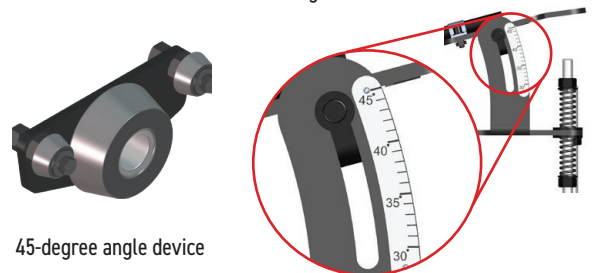

45-degree angle device

Trolley reference point set to 45-degrees

All information is subject to change without notice. 21.11



PROMOTECH Sp. z o.o.
 ul. Elewatorska 23/1, 15-620 BIAŁYSTOK, POLAND
 tel. (+48 85) 678 34 05, fax (+48 85) 662 78 77
 marketing@promotech.eu www.promotech.eu

Your local dealer:

